

Varenummer: 204380M1060D3SK
 Beskrivelse: E+G Justerfod
 GN 43-80-M10-60-D3-SK
 Note: SK Med møtrik, udvendig sekskant i bunden

Mål

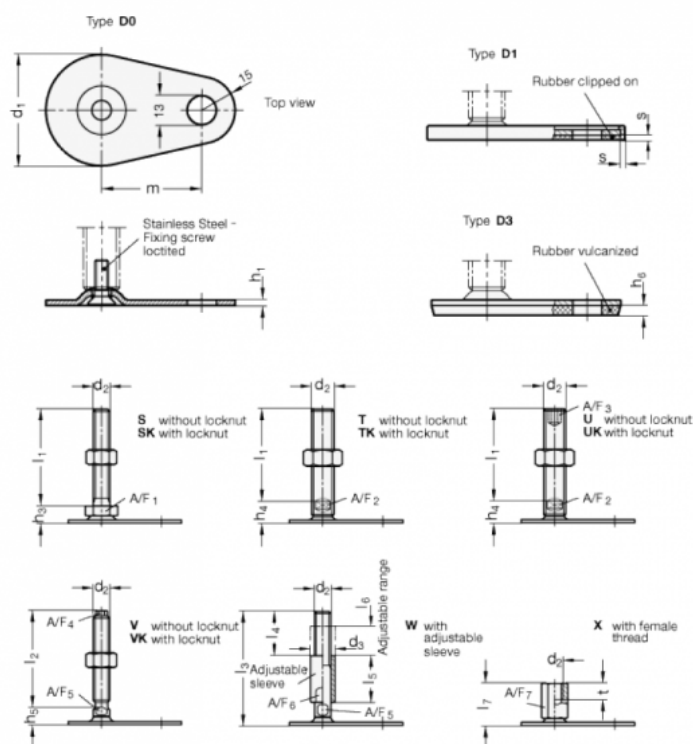

A/F1 = 17

d1 = 80

d2 = M10

h1 = 3

h3 = 12

h6 = 5

l1 = 60

m = 70

s =

